

GX/GF SERIES OPTIONS

OP-04 (Comparator output/RS-232C/
Current loop output)

OP-06 (Analog output/Current loop output)

INSTRUCTION MANUAL

© 2000 A&D Company Ltd. All rights reserved.

No part of this publication may be reproduced, transmitted, transcribed, or translated into any language in any form by any means without the written permission of A&D Company Ltd.

The contents of this manual and the specifications of the instrument covered by this manual are subject to change for improvement without notice.

CONTENTS

1. INTRODUCTION	2
1-1 Description of the Options	2
1-2 Accessories.....	3
2. FUNCTION TABLE	4
2-1 Structure and Sequence of the Function Table.....	4
2-2 Display and Keys	4
2-3 Details of the Function Table	5
3. COMPARATOR OUTPUT (OP-04)	8
3-1 Specifications.....	8
3-2 Using the Comparator Output.....	9
3-3 Setting the Upper and Lower Limit Values	10
3-4 Example of Use	12
4. SERIAL OUTPUT	13
4-1 RS-232C (OP-04) Specifications	13
4-2 Current Loop Output (OP-04/OP-06) Specifications	15
4-3 Connection to the AD-8121 Printer.....	16
4-4 Description of the Item "Data output mode".....	16
4-5 Description of the Item "Data format"	18
4-6 Description of the Data Format Added to the Weighing Data	19
4-7 Data Format Examples	20
4-8 Using Windows Communication Tools (WinCT).....	22
4-9 Commands	23
4-10 Acknowledge Code and Error Codes	25
4-11 Control Using CTS and RTS.....	25
4-12 Settings Related to RS-232C.....	25
5. ANALOG OUTPUT (OP-06)	26
5-1 Analog Output (OP-06) Specifications	26
5-2 Analog Output (<i>Rout</i>).....	27
5-3 Switching Output Voltage.....	29
5-4 Output Voltage Fine Adjustment	29
5-5 Fixed Output Voltage	30

1. INTRODUCTION

This manual describes how the GX/GF series options, OP-04 and OP-06 work, and how to get the most out of it in terms of performance.



Read this manual thoroughly before using the option and keep it at hand for future reference.

1-1 Description of the Options

The description of the options is as follows:

- OP-04: Comparator output with a buzzer / RS-232C / Current loop output
- OP-06: Analog output / Current loop output

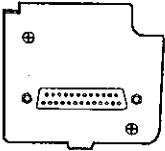
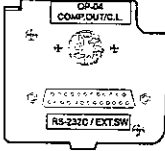
Functions and panel view

	Function				Panel view
	RS-232C	Current loop output	Comparator output	Analog output	
Standard • RS-232C	○	-	-	-	
OP-04 • Comparator output • RS-232C • Current loop output	○	○	○	-	
OP-06 • Analog output • Current loop output	-	○	-	○	

○:Available, -:Not available

Note 1 OP-04 and OP-06 can not be used at the same time. The current loop interface is of the passive type, and an external power supply that provides 20 mA, is required. The external power supply is not necessary when connecting an AD-8121 with this current loop interface.

Note 2 OP-04 or OP-06 must be installed at the factory before shipment. Installation by a user is not available.

■ Comparator output

Contact outputs: The comparison results between the weighing data and upper/lower limit values, using **HI**, **OK**, and **LO**

Whether or not to sound a buzzer, depending on the results, can be selected.

■ Analog output

Two modes are available: To convert the specified weight value digits to voltage, and to convert

the value, in the range from zero to the weighing capacity, to voltage.

Output voltage range selection: Using the slide switch located on the option panel, the output voltage range can be switched between 0-1 V and 0.2-1V. The default setting at shipment is 0-1V.

■ RS-232C

The RS-232C interface is used to communicate with a printer or a personal computer. Using the RS-232C interface, the following operations are available through a command from the computer:

- Outputs the weighing data.
- Enters balance settings.
- Controls the balance.
- Retrieves the balance settings.

■ Current loop

Current loop is a data output interface, mainly used as a printer interface.

■ GLP output

GLP-compliant data output is available for RS-232C and current loop. Refer to the balance instruction manual for details about GLP output.

1-2 Accessories

Each option is provided with the following accessories.

- OP-04: DIN connector (plug)

1 pc



Instruction manual (this document) 1 copy

- OP-06: DIN connector (plug)

1 pc



Screwdriver

1 pc

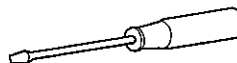

Instruction manual (this document) 1 copy

2. FUNCTION TABLE

The function table reads or rewrites the parameters that are stored in the balance. When the OP-04 or OP-06 is used, set the function table to specify the balance performance. These parameters stored, even if the AC adapter is removed, are maintained in non-volatile memory.

2-1 Structure and Sequence of the Function Table

The function table menu consists of two layers. The first layer is the "Class" and the second layer is the "Item". Each item stores a parameter.

Example

This example sets "Stores weighing data" for "Data memory" and "Every 1 minute" for "Interval time".

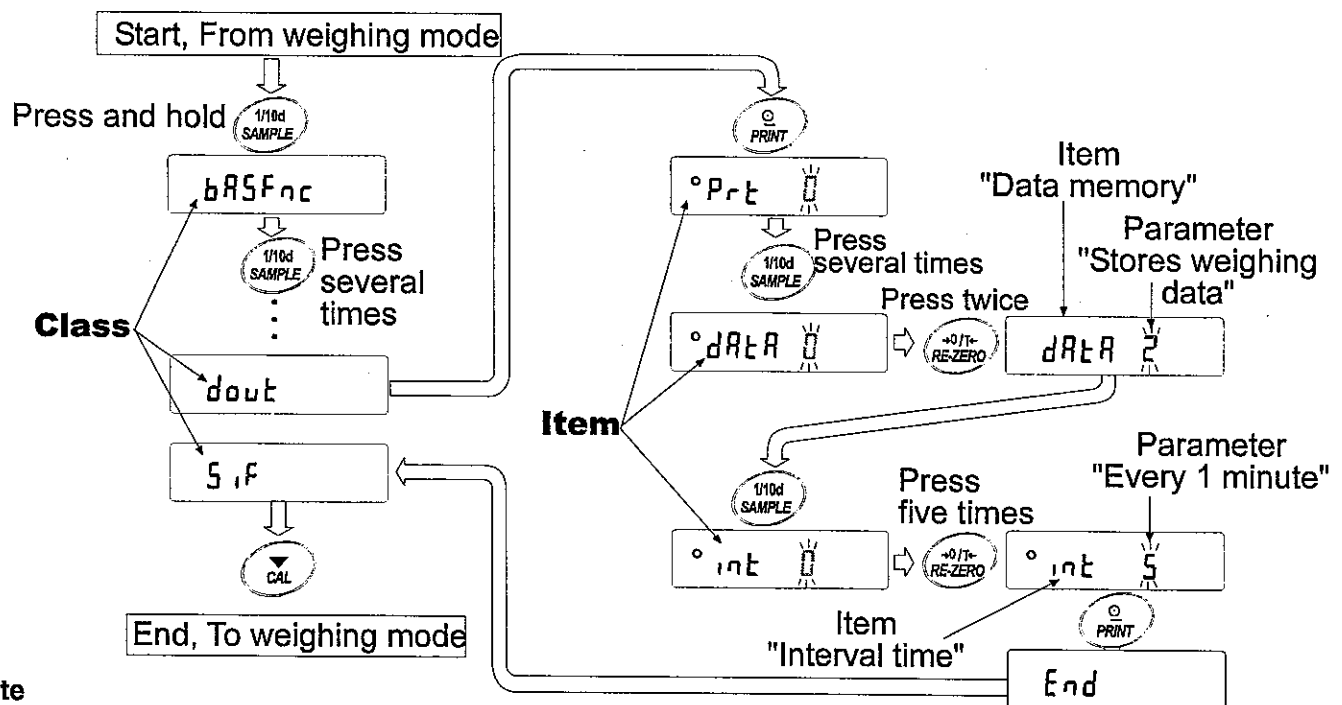



Note

The balance may not function properly, depending on the settings and the operating environment. Be sure to set parameters correctly.

2-2 Display and Keys

Display/Key	Description
°	The symbol "°" indicates that the parameter displayed is in effect.
1/10d SAMPLE	When pressed and held in the weighing mode, enters the function table mode. Selects the class or item in the function table mode.
RE-ZERO	Changes the parameter.
PRINT	When a class is displayed, moves to an item in the class. When an item is displayed, stores the new parameter and displays the next class.
CAL	When an item is displayed, cancels the new parameter and displays the next class. When a class is displayed, exits the function table mode and returns to the weighing mode.

2-3 Details of the Function Table

Class	Item	Parameter	Description		
bASFnC Environment Display	[Cond Condition	0 ▪ 1 2	 <input type="checkbox"/> Can be changed by response adjustment. With "Hold 1", sets the averaging time.		
	St-b Stability band width	0 ▪ 1 2	 ± ±		
	Hold Hold function	▪ 0 1	Holds the display when stable in animal mode. With "Hold 1", [ANIMAL] turns on.		
	Err Zero tracking	0 ▪ 1	Keeps zero display by tracking zero drift.		
	SPd Display refresh rate	▪ 0 1	Period to refresh the display		
	Pnt Decimal point	▪ 0 1	Decimal point format		
	P-on Auto display-ON	▪ 0 1	Turns on the weighing mode display when AC adapter is connected.		
	P-off Auto display-OFF	▪ 0 1	Turns off the display after 10 minutes of inactivity.		
	CSI Capacity indicator	▪ 0 1	Capacity indicator. Zero: 0% Maximum capacity: 100%		
[EL Add Clock (Only for the GX series)	See the balance instruction manual, "9-9 Clock and Calendar Function"		Confirms and sets the time and date. The time and date are added to output data.		
[P Fnc Comparator	Comparator mode	▪ 0	No comparison		
		1	Comparison, excluding "near zero" when stable value or overloaded		
		2	Comparison, including "near zero" when stable value or overloaded		
		3	Continuous comparison, excluding "near zero"		
[P in Input method		▪ 0	Digital input, upper/lower limits	[P H1, [P L0 can be selected.	
		1	Weighing input, upper/lower limits		
		2	Digital input, reference value		[P rEF, [P Lnt can be selected.
		3	Weighing input, reference value		
Displayed only when OP-04 is installed.	bEP- LO buzzer	▪ 0 1	OFF ON	Select whether or not to sound the buzzer for LO.	
	bEP- OK buzzer	▪ 0 1	OFF ON	Select whether or not to sound the buzzer for OK.	
	bEP- HI buzzer	▪ 0 1	OFF ON	Select whether or not to sound the buzzer for HI.	
[P H1 Upper limit	See "3 COMPARATOR OUTPUT" of this manual.		Displayed when [P in 0 or [P in 1 is selected.		
[P L0 Lower limit					
[P rEF Reference value	See "3 COMPARATOR OUTPUT" of this manual.		Displayed when [P in 2 or [P in 3 is selected.		
[P Lnt Tolerance					

▪ Factory setting **Note:** "Digit" is a unit of minimum weighing value.
Available functions depend on the balance model.

Class	Item	Parameter	Description
<i>dout</i> Data output	<i>Prt</i> Data output mode	0	Key mode Accepts the PRINT key only when the display is stable.
		1	Auto print mode A (Reference = zero) Outputs data when the display is stable and conditions of <i>RP-P</i> , <i>RP-b</i> and the reference value are met.
		2	Auto print mode B (Reference = last stable value)
		3	Stream mode / Interval memory mode With <i>dRtR</i> 0, outputs data continuously; with <i>dRtR</i> 2, uses interval memory.
	<i>RP-P</i> Auto print polarity	0	Plus only Displayed value > Reference
		1	Minus only Displayed value < Reference
		2	Both Regardless of displayed value
	<i>RP-b</i> Auto print difference	0	10 digits Difference between reference value and displayed value
		1	100 digits
		2	1000 digits
	<i>dRtR</i> Data memory	0	Not used
		1	Stores unit mass in counting mode
		2	Stores weighing data
		3	Stores calibration data (GX series only)
	<i>int</i> Interval time	0	Every measurement
		1	Every 2 seconds
		2	Every 5 seconds
		3	Every 10 seconds
		4	Every 30 seconds
		5	Every 1 minute
		6	Every 2 minutes
		7	Every 5 minutes
	8	Every 10 minutes	
	<i>d-no</i> Data number output	0	No output See the balance instruction manual, "11 DATA MEMORY".
		1	Output
	<i>S-t-d</i> Time/Date output (Only for the GX series)	0	No output Selects whether or not the time or date is added to the weighing data.
		1	Time only
2		Date only	
<i>S-id</i> ID number output	0	No output Selects whether or not the ID number is output.	
	1	Output	
<i>PUSE</i> Data output pause	0	No pause Selects the data output interval.	
	1	Pause (1.6 seconds)	
<i>Rt-F</i> Auto feed	0	Not used Selects whether or not auto feed is performed.	
	1	Used	
<i>inFa</i> GLP output	0	No output Selects GLP output method. For how to set time and date to be added, refer to the balance instruction manual, "9-9 Clock and Calendar Function".	
	1	AD-8121 format	
	2	General data format	
<i>Rr-d</i> Zero after output	0	Not used Adjusts zero automatically after data is output.	
	1	Used	

■ Factory setting

Class	Item	Parameter	Description		
5, F Serial interface	bPS Baud rate	0	600 bps		
		1	1200 bps		
		▪ 2	2400 bps		
		3	4800 bps		
		4	9600 bps		
	bPr Data bit, parity bit	▪ 0	7 bits, even		
		1	7 bits, odd		
		2	8 bits, none		
	CrLF Terminator	▪ 0	CR LF	CR: ASCII code 0Dh	
		1	CR	LF: ASCII code 0Ah	
	tYPE Data format	▪ 0	A&D standard format		
		1	DP format	See the balance	
		2	KF format	instruction manual, "9-6	
		3	MT format	Description of Item "Data	
4		NU format	Format"		
t-UP Timeout	0	No limit			
	▪ 1	1 second	Selects the wait time to	receive a command.	
ErEd AK, Error code	▪ 0	No output			
	1	Output	AK: ASCII code 06h		
tES CTS, RTS control	▪ 0	Not used			
	1	Used	Controls CTS and RTS.		
dS Fnc Density function	Ld in Liquid density input	▪ 0	Water temperature	Available only when density	
		1	Liquid density	mode is selected. See the	
nLt Programmable-unit (Multi-unit)			Sets an arbitrary coefficient.	balance instruction manual,	
Unit Unit				"14. DENSITY	
ES in Internal mass value correction (Only for the GX series)			See the balance instruction manual,	MEASUREMENT".	
Aout Analog output	An Analog output mode	0	2-digit output	Displayed only when the	
		1	3-digit output		the OP-06 is connected.
		▪ 2	Net full scale output		
		3	Gross full scale output		
	SEL Output digit selection	▪ 0	First digit	Displayed only when	
		1	Second digit		the OP-06 is connected.
		2	Third digit		
		3	Fourth digit		
		4	Fifth digit		
		5	Sixth digit		
ID ID number setting			See the balance instruction manual, "10. ID NUMBER AND GLP	REPORT".	

▪ Factory setting

Caution

The balance may not transmit the data completely at the specified refresh rate, depending on the baud rate or data added to the weighing data such as time, date and ID number.

3. COMPARATOR OUTPUT (OP-04)

Comparator output, is the function to output the comparison results between the weighing data and upper/lower limit values. Whether or not to sound the buzzer when the contact is shorted can be set.

3-1 Specifications

The specifications of the comparator output are as follows:

Maximum contact voltage: 100 VDC

Maximum contact current: 100 mA DC

Maximum contact resistance: 20 Ω

Comparator output judgement conditions (when upper limit value \geq lower limit value):

Weighing data $>$ upper limit value: Shorts HI comparator output.

Upper limit value \geq weighing data \geq lower limit value: Shorts OK comparator output.

Weighing data $<$ lower limit value: Shorts LO comparator output.

Reference value setting: Input the upper and lower limit values digitally, using a sample or using commands.

Contact output: Select whether or not to compare in the function in $\mathcal{E}P$, comparator mode of the balance function table.

Buzzer: Select whether or not to sound the buzzer in $b\mathcal{E}P$, buzzer mode of the balance function table.

Panel view

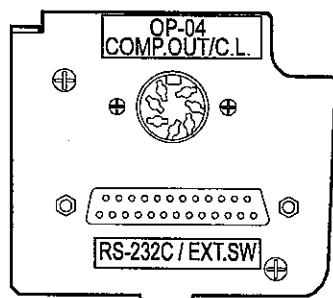

Circuit

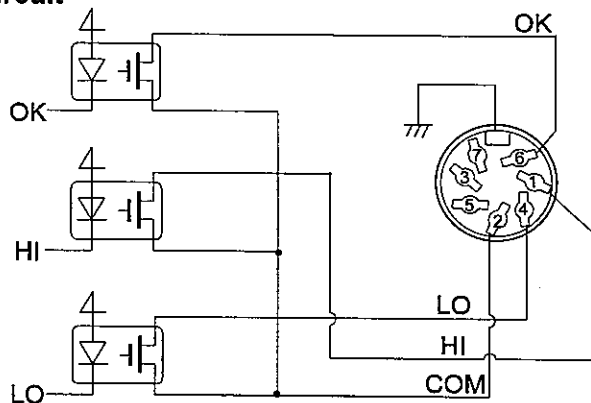

Pin assignments

Pin No.	Description
1	HI (Comparator)
2	COM (Comparator)
3	Sending loop (Current loop)
4	LO (Comparator)
5	Sending loop (Current loop)
6	OK (Comparator)
7	No connection
Housing	Shield

For details on current loop, pins 3 and 5, see "4-2 Current Loop Output Specifications" on page 15.

3-2 Using the Comparator Output

To use the comparator output, perform the following four steps.

1. Connect the peripheral to the option's 7-pin DIN connector.
2. Set the "Comparator ($[P Fnc]$)" of the balance function table. For details, see "2. FUNCTION TABLE".
3. Set the upper and lower limit values. For details, see "3-3 Setting the Upper and Lower Limit values".
4. Perform a weighing. The comparison results will be output.
When the weighing data is equal to or less than the upper limit value, and equal to or greater than the lower limit value, the OK comparator output will be shorted.

Comparator output	LO	OK	HI
Weighing data > upper limit	Open	Open	Short
Upper limit \geq weighing data \geq lower limit	Open	Short	Open
Weighing data < lower limit	Short	Open	Open

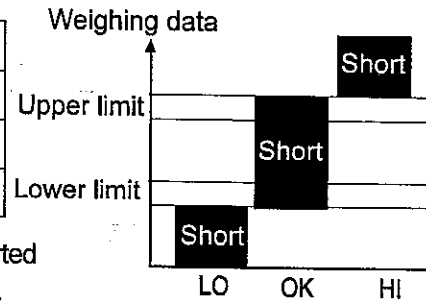

Whether or not to sound the buzzer when the contact output is shorted can be set in the "Buzzer mode (bEP)" of the "Comparator ($[P Fnc]$)".

Note

When setting the upper and lower limit values, make sure that the upper limit value is greater than the lower limit value.

Class	Item	Parameter	Description		
$[P Fnc]$ Comparator	$[P]$ Comparator mode	0	No comparison		
		1	Comparison, excluding "near zero" when stable value or overloaded		
		2	Comparison, including "near zero" when stable value or overloaded		
		3	Continuous comparison, excluding "near zero"		
		4	Continuous comparison, including "near zero"		
	$[P in]$ Input method	0	Digital input, upper/lower limits	$[P Hi]$, $[P Lo]$ can be selected.	
		1	Weighing input, upper/lower limits		
		2	Digital input, reference value		$[P rEF]$, $[P \bar{n}t]$ can be selected.
		3	Weighing input, reference value		
	Displayed only when OP-04 is installed.	bEP_{LO} LO buzzer	0	OFF	Select whether or not to sound the buzzer for LO.
1			ON		
bEP_{OK} OK buzzer		0	OFF	Select whether or not to sound the buzzer for OK.	
	1	ON			
bEP_{HI} HI buzzer	0	OFF	Select whether or not to sound the buzzer for HI.		
	1	ON			
$[P Hi]$ Upper limit		See "3 COMPARATOR OUTPUT" of this manual.	Displayed when $[P in 0]$ or $[P in 1]$ is selected.		
$[P Lo]$ Lower limit					
$[P rEF]$ Reference value		See "3 COMPARATOR OUTPUT" of this manual.	Displayed when $[P in 2]$ or $[P in 3]$ is selected.		
$[P \bar{n}t]$ Tolerance					

▪ Factory setting

3-3 Setting the Upper and Lower Limit Values

The results of the comparison are indicated by **HI** **OK** **LO** on the display.

Operating conditions:

- No comparison

- Comparison when the weighing data is stable or overloaded, excluding "near zero"
- Comparison when the weighing data is stable or overloaded, including "near zero"
- Continuous comparison, excluding "near zero"
- Continuous comparison, including "near zero"

To compare, use:

- Upper limit value and lower limit value
- Reference value and tolerance value

Input method:

- Digital input
- Weighing input

Setting example 1

(Continuous comparison, excluding "near zero", reference value and tolerance value, digital input)

Selecting a comparator mode

- 1 Press and hold the **SAMPLE** key until **bRSFnC** of the function table is displayed.
- 2 Press the **SAMPLE** key several times to display **[P Fnc]**.
- 3 Press the **PRINT** key.
- 4 Press the **RE-ZERO** key several times to display **[P 3]**.
- 5 Press the **SAMPLE** key several times to display **[P in]**.
- 6 Press the **RE-ZERO** key several times to display **[P in 2]**.
- 7 Press the **PRINT** key to store the selected mode.

Entering the reference and tolerance values

- 8 With **[P rEF]** displayed, press the **PRINT** key. The current setting is displayed with all the digits blinking.
 - When the current setting is not to be changed, press the **PRINT** or **CAL** key to proceed to step 9.
 - When the current setting is to be changed, press the **RE-ZERO** key. Change the setting using the following keys.

SAMPLE key To select the digit to change the value.

RE-ZERO key To change the value of the digit selected.

MODE key To switch the polarity.

PRINT key To store the new setting and go to step 9.

CAL key To cancel the new setting and go to step 9.

- 9 With $[CP L\bar{n}t]$ displayed, press the $[PRINT]$ key. The current setting is displayed. When the current setting is to be changed, change the setting using the following keys. Enter the tolerance value in percentage to the reference value as 100%.

- $[SAMPLE]$ key To select the digit to change the value.
 $[RE-ZERO]$ key To change the value of the digit selected.
 $[PRINT]$ key To store the new setting and go to step 10.
 $[CAL]$ key To cancel the new setting and go to step 10.

- 10 Press the $[CAL]$ key to exit the comparator function and return to the weighing mode.

Setting example 2

(Comparison when the weighing data is stable or overloaded, including "near zero", upper limit and lower limit, weighing input)

Selecting a comparator mode

- 1 Press and hold the $[SAMPLE]$ key until $bRSFnC$ of the function table is displayed.
- 2 Press the $[SAMPLE]$ key several times to display $[P Fnc]$.
- 3 Press the $[PRINT]$ key.
- 4 Press the $[RE-ZERO]$ key several times to display $[P 2]$.
- 5 Press the $[SAMPLE]$ key several times to display $[P in]$.
- 6 Press the $[RE-ZERO]$ key several times to display $[P in 1]$.
- 7 Press the $[PRINT]$ key to store the selected mode.

Entering the upper and lower limit values

- 8 With $[P H_1]$ displayed, press the $[PRINT]$ key. The current setting is displayed with all of the digits blinking. Press the $[RE-ZERO]$ key to enter the weighing input mode.
- 9 Press the $[RE-ZERO]$ key. The balance displays $000g$. Place a sample whose mass corresponds to the upper limit value on the pan. Press the $[PRINT]$ key to store the upper limit value. Remove the sample. The balance displays $[P L_0]$.
- 10 With $[P L_0]$ displayed, press the $[PRINT]$ key. The current setting is displayed with all of the digits blinking. Press the $[RE-ZERO]$ key to enter the weighing input mode.
- 11 Press the $[RE-ZERO]$ key. The balance displays $000g$. Place a sample whose mass corresponds to the lower limit value on the pan. Press the $[PRINT]$ key to store the lower limit value. Remove the sample.
- 12 Press the $[CAL]$ key to exit the comparator function and return to the weighing mode.

Notes

When Pound/Ounce is selected as a weighing unit, enter the values in ounces for comparison.

In the density mode, comparison is performed to the density obtained.

3-4 Example of Use

The following example uses the AD-8951 comparator light, which is sold separately, to display the comparison result in red, green, or orange.

- Using the AX-KO507-W200 cable sold separately, connect the comparator light to the balance as shown below.

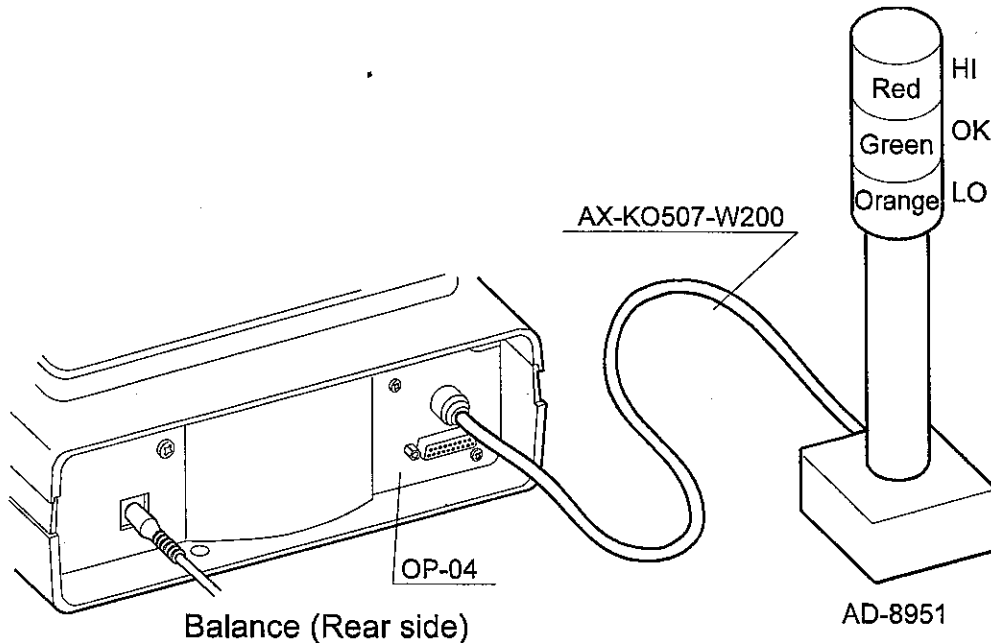

- Set the "Comparator (*CP Fnc*)" of the balance function table as follows:
 - CP 3* Compares the result excluding the data near zero continuously.
 - CP in 0* Inputs the upper or lower limit values digitally.
 - bEP- 1* Sounds the buzzer for LO.
 - bEP- 0* Does not sound the buzzer for OK.
 - bEP- 1* Sounds the buzzer for HI.

- Set the upper and lower limit values as follows:

CP Hi 101.000 g (Upper limit)

CP Lo 99.000 g (Lower limit)

- The comparator and buzzer functions as follows, depending on the comparison result.

Weighing data	Comparator light	Buzzer
90.000 g	Orange	Sounds
100.00 g	Green	Does not sound
110.000 g	Red	Sounds

4. SERIAL OUTPUT

4-1 RS-232C (OP-04) Specifications

The specifications of the RS-232C are as follows:

Transmission system	EIA RS-232C
Transmission	Asynchronous, bi-directional, half-duplex
Data format	Baud rate: 600, 1200, 2400, 4800, 9600 bps
	Data: 7 or 8 bits
	Parity: Even, Odd (Data 7 bits)
	None (Data 8 bits)
	Stop bit: 1 bit
	Code: ASCII

Bit format

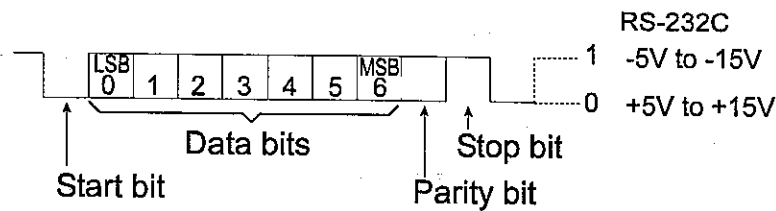

Pin assignments

Pin No.	Signal	Direction	Description
1	FG	-	Frame ground
2	RXD	Input	Receive data
3	TXD	Output	Transmit data
4	RTS	Input	Request to send
5	CTS	Output	Clear to send
6	DSR	Output	Data set ready
7	SG	-	Signal ground
8-17	-	-	No connection
18	PRINT	Input	Same as the PRINT key
19	RE-ZERO	Input	Same as the RE-ZERO key
20-25	-	-	No connection

Circuit

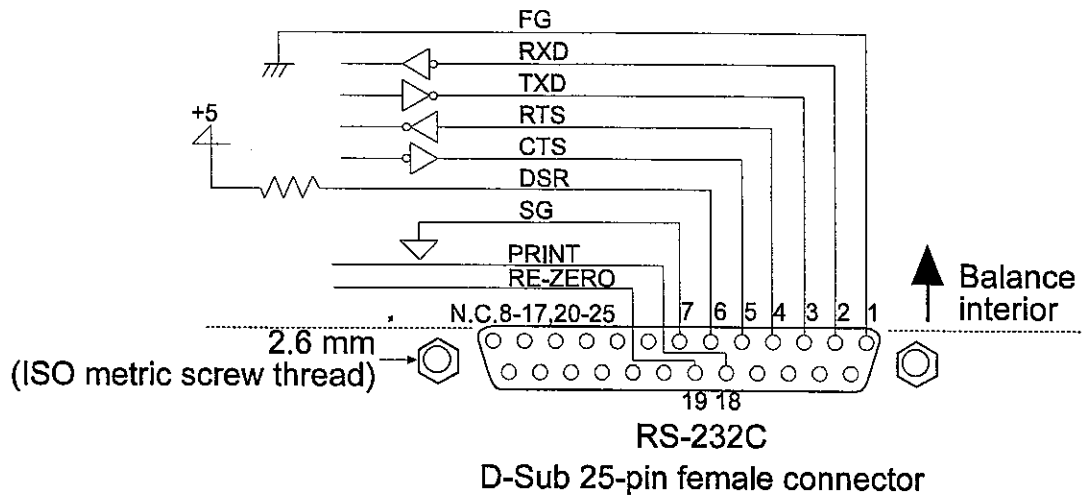

External input

Pin 18 and pin 19 perform the same function as pressing the **PRINT** and **RE-ZERO** keys respectively by connecting each pin to pin 7 for at least 100 m seconds.

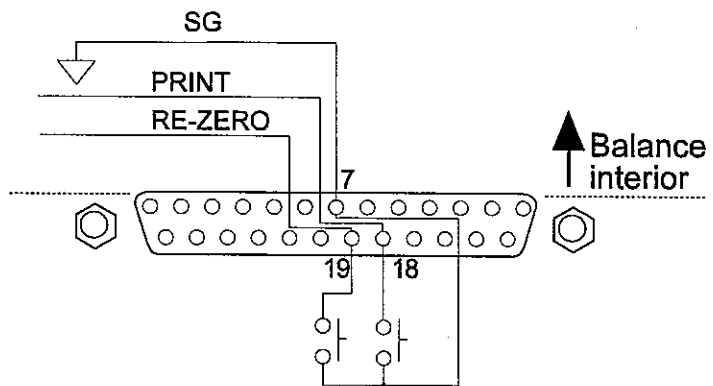

4-2 Current Loop Output (OP-04/OP-06) Specifications

The specifications of the current loop interface are as follows:

Transmission system	20 mA current loop (Passive)
Transmission	Asynchronous, uni-directional (Only from the balance)
Data format	Baud rate: 600, 1200, 2400, 4800, 9600 bps
	Data: 7 or 8 bits
	Parity: Even, Odd (Data 7 bits)
	None (Data 8 bits)
	Stop bit: 1 bit
	Code: ASCII

Data	Current loop (20 mA)
1	20 mA
2	0 mA

Notes

To use current loop, an external power supply that provides 20 mA, is required.

The maximum rated voltage of the current loop is 25 V.

Circuit

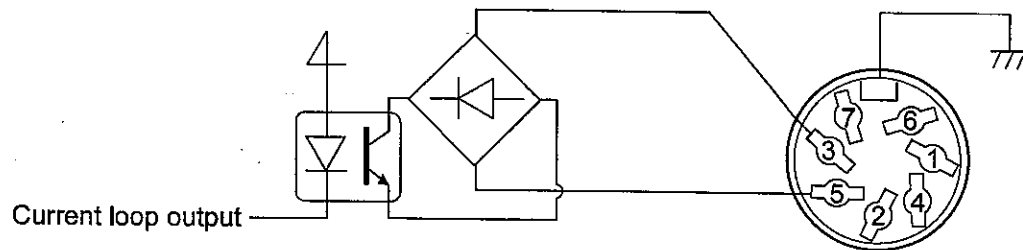

Pin assignments

OP-04

Pin No.	Description
1	HI
2	COM
3	Sending loop (Current loop)
4	LO
5	Sending loop (Current loop)
6	OK
7	No connection
Housing	Shield

OP-06

Pin No.	Description
1	No connection
2	Analog GND
3	Sending loop (Current loop)
4	No connection
5	Sending loop (Current loop)
6	No connection
7	Analog output
Housing	Shield

4-3 Connection to the AD-8121 Printer

Set the following parameters to use the AD-8121 printer.

Function setting	Description
<i>dout Prt</i> 0-3	Selects a print mode.
<i>dout AP-P</i> 0-2	Selects the polarity for the auto print mode.
<i>dout AP-b</i> 0-2	Selects the auto print difference.
<i>dout PUSE</i> 0,1	Selects data output pause.
<i>Sif bPS</i> 2 Factory setting	2400 bps
<i>Sif btPr</i> 0 Factory setting	7 bits, Even parity check
<i>Sif CrLF</i> 0 Factory setting	CR, LF
<i>Sif Cts</i> 0 Factory setting	CTS and RTS control, not used

When "MODE 1" or "MODE 2" of the AD-8121 printer is used	
<i>dout S-td</i> 0 Factory setting	Does not output time and date. (Only for the GX series)
<i>dout S-id</i> 0 Factory setting	Does not output ID number.
<i>dout Rt-F</i> 0 Factory setting	Does not perform auto feed.
<i>Sif TYPE</i> 0 Factory setting	A&D standard format

When "MODE 3" of the AD-8121 printer is used.	
<i>dout S-td</i> 0-3 Factory setting	Outputs time and date as necessary. (Only for the GX series)
<i>dout S-id</i> 0, 1 Factory setting	Outputs ID number as necessary.
<i>dout Rt-F</i> 0, 1 Factory setting	Performs auto feed as necessary.
<i>Sif TYPE</i> 1	DP format

When data is transmitted continuously. When all memory data is transmitted at one time. When ID number, time and date are added to the weighing data or auto feed is performed.	
<i>dout PUSE</i> 1	Uses pause.

AD-8121 Printer

- Compact dot-matrix printer
- Statistical function, clock and calendar function, interval print function, graphic print function, terminal mode
- 5 x 7 dots, 16 characters per line
- AC adapter or alkaline battery.

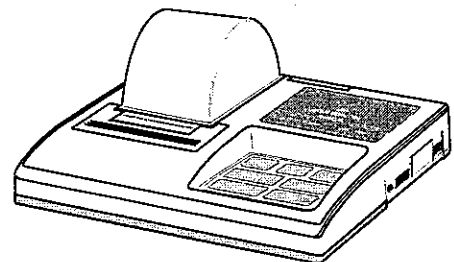

4-4 Description of the Item "Data output mode"

The parameter setting of the "Data output mode (*Prt*)" applies to the performance when the "Data memory (*dRtA*)" parameter is set to "2" (to store the weighing data) and when the data is transmitted using the RS-232C interface.

Key mode

When the **PRINT** key is pressed with the stabilization indicator turned on, the balance outputs or stores the weighing data and the display blinks one time.

Required setting *dout Prt* 0 Key mode

Auto print modes A and B

When the displayed value is stable and the conditions of "Auto print polarity", "Auto print difference" and reference value are met, the balance outputs or stores the weighing data.

When the **PRINT** key is pressed with the stabilization indicator turned on, the balance outputs or stores the data and the display blinks one time.

Mode A: Required setting	<i>dout</i>	<i>Prt 1</i>	Auto print mode A (reference = zero)
	<i>dout</i>	<i>RP-P</i>	Auto print polarity
	<i>dout</i>	<i>RP-b</i>	Auto print difference

Example "For weighing each time a sample is placed and removed."

Mode B: Required setting	<i>dout</i>	<i>Prt 2</i>	Auto print mode B (reference = last stable value)
	<i>dout</i>	<i>RP-P</i>	Auto print polarity
	<i>dout</i>	<i>RP-b</i>	Auto print difference

Example "For weighing while a sample is added."

Stream mode

The balance outputs the weighing data continuously regardless of the display condition. The display does not blink in this mode. This mode is not available and the interval memory mode is used when the "Data memory (*dARR*)" parameter is set to "2" (to store the weighing data).

Required setting	<i>dout</i>	<i>Prt 3</i>	Stream mode
	<i>dout</i>	<i>dARR 0</i>	Data memory function is not used.
	<i>bRSFnc</i>	<i>SPd</i>	Display refresh rate
	<i>Sif</i>	<i>bPS</i>	Baud rate

Example "For monitoring data on a computer"

Caution

The balance may not transmit the data completely at the specified refresh rate, depending on the baud rate or data added to the weighing data such as time, date and ID number.

Interval memory mode

The weighing data is periodically stored in memory.

Required setting	<i>dout</i>	<i>Prt 3</i>	Interval memory mode
	<i>dout</i>	<i>dARR 2</i>	Data memory function is used. Stores weighing data.
	<i>dout</i>	<i>int</i>	Interval time

Optional setting *dout* *S-t d 1, 2, or 3* Adds the time and date.
(Only for the GX series)

Example "For periodical weighing without a computer command and to output all of the data, to a computer, at one time"

4-5 Description of the Item "Data format"

A&D standard format *SIF TYPE 0*

This format is used when the peripheral equipment can receive the A&D format. If an AD-8121 is used, set the printer to MODE 1 or 2.

- This format consists of fifteen characters excluding the terminator.
- A header of two characters indicates the balance condition.
- The polarity sign is placed before the data with the leading zeros. If the data is zero, the plus sign is used.
- The unit, consisting of three characters, follows the data.

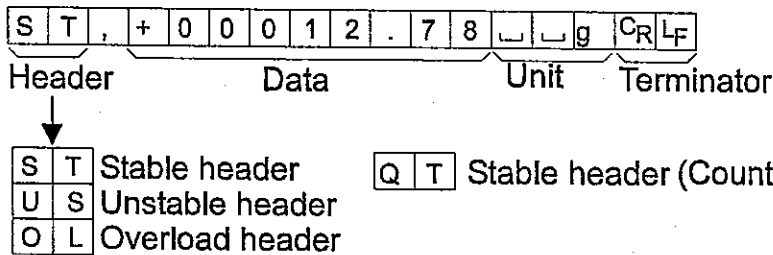

DP (Dump print) format *SIF TYPE 1*

This format is used when the peripheral equipment can not receive the A&D format. If an AD-8121 is used, set the printer to MODE 3.

- This format consists of sixteen characters excluding the terminator.
- A header of two characters indicates the balance condition. No overload header is used.
- The polarity sign is placed before the data, with spaces in place of leading zeros, if the data is not zero or overloaded.
- The unit, consisting of three characters, follows the data.

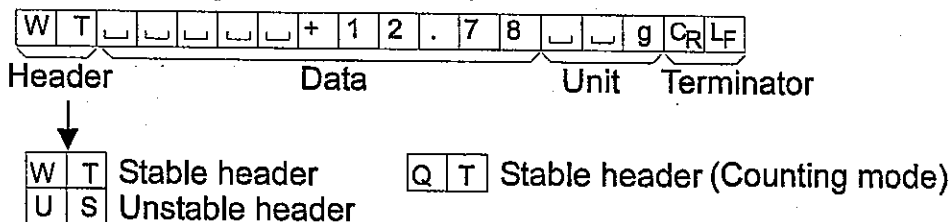

KF format *SIF TYPE 2*

This is the Karl-Fischer moisture meter format and is used when the peripheral equipment can only communicate using this format.

- This format consists of fourteen characters excluding the terminator.
- This format has no header characters.
- The polarity sign is placed before the data, with spaces in place of leading zeros, if the data is not zero or overloaded.
- This format outputs the unit only for a stable value.

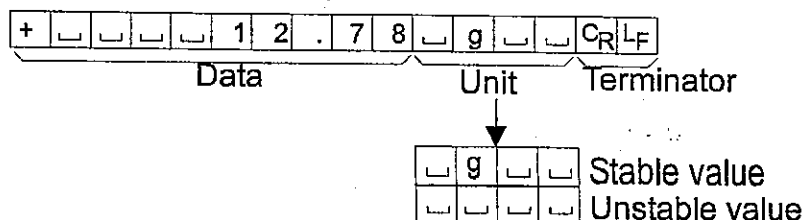

MT format 5 IF TYPE 3

- A header of two characters indicates the balance condition.
- The polarity sign is used only for negative data.
- The weighing data uses spaces in place of the leading zeros.
- The character length of this format changes dependent upon the unit

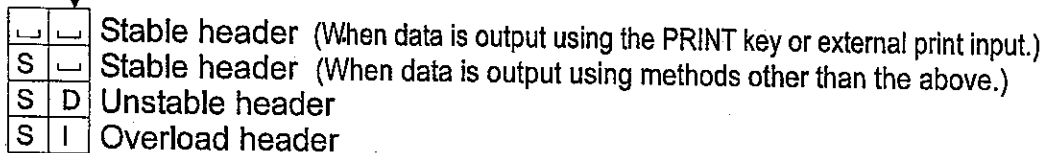
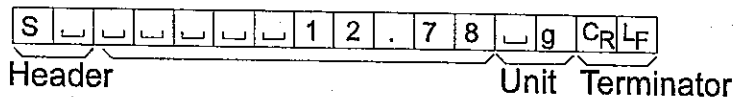

NU (numerical) format 5 IF TYPE 4

This format outputs only numerical data.

- This format consists of nine characters excluding the terminator.
- The polarity sign is placed before the data with the leading zeros. If the data is zero, the plus sign is used.

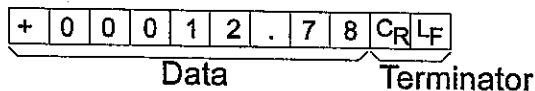

CSV format 5 IF TYPE 5

- Separates the data of A&D standard format and the unit by a comma (,).
- Outputs the unit even when the data is overloaded.
- When ID number, data number, time and date are added, outputs ID number, data number, date, time and weighing data in this order and separates each item by a comma and treats all the items as one group of data.

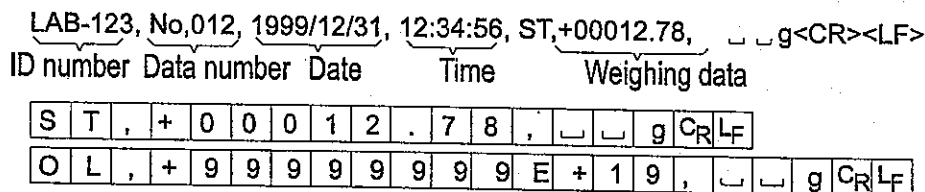

4-6 Description of the Data Format Added to the Weighing Data

ID number *dout 5-id 1*

The number to identify a specific balance.

- This format consists of seven characters excluding the terminator.

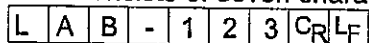

Data number *dout d-no 1*

This format outputs the data number just before the data is transmitted using the RS-232C interface.

- This format consists of six characters excluding the terminator.
- When CSV format (5if type 5) is selected, the period (.) is replaced with a comma (,).

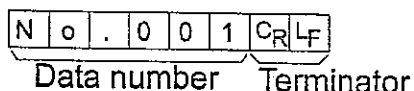

Date *dout 5-td 2 or 3* (Only for the GX series)

- The date output order can be changed in "Clock (CL Adj)". Outputs the year in four-digit format.

2	0	0	0	/	0	7	/	0	1	C _R	L _F
---	---	---	---	---	---	---	---	---	---	----------------	----------------

Time *dout 5-td 1 or 3* (Only for the GX series)

- Outputs time in 24-hour format.

1	2	:	3	4	:	5	6	C _R	L _F
---	---	---	---	---	---	---	---	----------------	----------------

Note

When the data described above is added to the weighing data, the output is in the following order: ID number, Data number, Date, Time and Weighing data.

4-7 Data Format Examples

Stable

°	127	g
---	-----	---

A&D	S	T	,	+	0	0	0	0	1	.	2	7					C _R	L _F	
DP	W	T								+	1	.	2	7			g	C _R	L _F
KF	+								1	.	2	7		g				C _R	L _F
MT*1										1	.	2	7		g			C _R	L _F
MT*2	S									1	.	2	7		g			C _R	L _F
NU	+	0	0	0	0	1	.	2	7									C _R	L _F

Note

Two formats are available for MT. *1 is the output format when the PRINT key or external print input is used. *2 is the output format for others.

Unstable

-18369	g
--------	---

A&D	U	S	,	-	0	0	1	8	3	.	6	9			g		C _R	L _F		
DP	U	S								-	1	8	3	.	6	9		g	C _R	L _F
KF	-									1	8	3	.	6	9				C _R	L _F
MT	S	D								-	1	8	3	.	6	9			C _R	L _F
NU	-	0	0	1	8	3	.	6	9									C _R	L _F	

Overload
Positive error

E	g
---	---

A&D	O	L	,	+	9	9	9	9	9	9	9	E	+	1	9			C _R	L _F	
DP																			C _R	L _F
KF										H									C _R	L _F
MT	S	I	+																C _R	L _F
NU	+	9	9	9	9	9	9	9	9										C _R	L _F

Overload
Negative error

-E	g
----	---

A&D	O	L	,	-	9	9	9	9	9	9	E	+	1	9				C _R	L _F	
DP																			C _R	L _F
KF										L									C _R	L _F
MT	S	I	-																C _R	L _F
NU	-	9	9	9	9	9	9	9	9										C _R	L _F

- Space, ASCII 20h
- C_R Carriage Return, ASCII 0Dh
- L_F Line Feed, ASCII 0Ah

Units		A&D	D.P.	KF	MT
g	g	□□g	□□g	□g□□	□g
Counting mode	PC	□PC	□PC	□p c s	□P C S
Precent mode	Pct	□□%	□□%	□%□□	□%
Ounce (Avoir)	OZ	□oz	□oz	□oz□	□oz
Pound	Lb	□lb	□lb	□lb□	□lb
Pound Ounce	L OZ	□oz	□oz	□oz□	□oz
Troy Ounce	OZt	ozt	ozt	□ozt	□ozt
Metric Carat	ct	□ct	□ct	□ct□	□ct
Momme	mm	m o m	m o m	□m o m	□m o
Pennyweight	dwt	d w t	d w t	□d w t	□d w t
Grain	GN	□GN	□GN	□g r □	□GN
Tael (HK general, Singapore)	TL	□t l	□t l	□t l s	□t l
Tael (HK; jewelry)	TL	□t l	□t l	□t l h	□t l
Tael (Taiwan)	TL	□t l	□t l	□t l t	□t l
Tael (China)	TL	□t l	□t l	□t l c	□t l
Tola (India)	t	□□t	□□t	□t o l	□t
Messghal	MS	m e s	m e s	□M S □	□m
Density	DS	□D S	□D S	□D S □	□D S
Multi	(Blank)	□□□	□□□	□□□□	□

□ Space, ASCII 20h

Note

When "Pound Ounce" is selected, the data is output with the unit of ounce (oz).

4-8 Using Windows Communication Tools (WinCT)

When Windows 95 or 98 is used as an operating system in a personal computer, the provided WinCT software can be used to transmit the weighing data to the personal computer.

The WinCT has two communication methods: "RsCom" and "RsKey". For details on WinCT, refer to the WinCT instruction manual.

RsCom

- Can transmit commands to control the balance.
- Can make bi-directional communication between the balance and a personal computer using the RS-232C interface.
- Can display or store the data using a text file format. Can also print the data using a printer connected to the personal computer.
- When several ports of a personal computer have balances connected, can communicate with each balance simultaneously.
- Can share a personal computer with other application software.
- Can receive the balance GLP report.

RsKey

- Can transmit the weighing data output from the balance directly to other application software such as Microsoft Excel.
- Can be used with most application software.
- Can receive the balance GLP report.

Note

Windows and Excel are the registered trademarks of the Microsoft Corporation.

Using the WinCT software, the balance can do the following:

- 1 Analyzing the weighing data and the statistics with "RsKey"
The weighing data can be input directly into an Excel worksheet. Then, Excel can analyze the data to obtain total, average, standard deviation, maximum and minimum value, and display them in a graph.
- 2 Controlling the balance using commands from a personal computer
By using "RsCom", the personal computer sends commands such as "re-zero" or "send weighing data" to the balance and controls the balance.
- 3 Printing the balance GLP report using your printer
The balance GLP report can be printed using a printer connected to the personal computer.
- 4 Receiving weighing data at a certain interval
The weighing data can be received at a certain interval and data characteristic with elapsed time can be obtained.

Commands to control the counting mode

UW: ***	Set the unit mass	e.g., "UW+0.123 g" Set the unit mass to 0.123 g.	Be sure to set the unit mass in grams. When the "Data memory (dRtR)" parameter is set to "I", this command sets the unit mass of the current unit mass number in memory.
UN:mm	Change the unit mass number in memory	e.g., "UN:03" Select the unit mass of the unit mass number 03 stored in memory.	Available only when the "Data memory (dRtR)" parameter is set to "I". Be sure to use a two-digit number 01 to 20 for the unit mass number.
?UW	Output the unit mass.	e.g., "UW, +0.123000 g" Output the unit mass.	When the "Data memory (dRtR)" parameter is set to "I", this command outputs the unit mass of the current unit mass number in memory
?UN	Output the unit mass number	e.g., "UN, 03" Output the unit mass number currently selected.	Available only when the "Data memory (dRtR)" parameter is set to "I".

Notes

"mm" indicates a two-digit numerical value.

" " indicates a space.

Commands to control the comparator function

HI: ***	Set the upper limit value.	e.g., "HI:+2.34 g" Set the upper limit value to 2.34 g.	Be sure to select the weighing unit or mode before setting the upper and lower limit values.
LO: ***	Set the lower limit value.	e.g., "LO:+1.23 g" Set the lower limit value to 2.34 g.	For the unit, use a three-digit format, the same as the A&D standard format.
?HI	Output the upper limit value.	e.g., "HI, +00002.34 g"	The leading zeros precede the upper or lower limit value with the unit in a three-digit format, the same as the A&D standard format.
?LO	Output the lower limit value.	e.g., "LO, +00001.23 g"	

4-10 Acknowledge Code and Error Codes

When the "Serial interface function (*S iF*)" parameter is set to "ErEd 1", the balance outputs <AK> code or an error code for each command as follows:

<AK> (06h) Acknowledge in ASCII code.

- When the balance receives a command to request data and can not process it, the balance transmits an error code (EC, Exx).
When the balance receives a command to request data and can process it, the balance outputs the data.

- When the balance receives a command to control the balance and can not process it, the balance transmits an error code (EC, Exx).

When the balance receives a command to control the balance and can process it, the balance transmits the acknowledge code.

Among commands to control the balance, the following transmit the acknowledge code both when the balance receives the command and when the balance has accomplished the command. If the command can not be processed properly, the balance transmits an error code (EC, Exx). This error can be released using the CAL command.

CAL command (Calibration command)

ON command (Display ON command)

P command (Display ON/OFF command)

R command (RE-ZERO command)

- When a communication error has occurred due to external noise, or a parity error has occurred due to transmission error, the balance transmits an error code. In this case, send the command again.

4-11 Control Using CTS and RTS

Depending on the "CTS" parameter of "Serial interface (*S iF*)", the balance performs as follows:

CTS 0

Regardless of whether the balance can receive a command or not, the balance keeps the CTS line Hi. The balance outputs data regardless of the condition of the RTS line.

CTS 1

The CTS line is kept Hi normally. When the balance can not receive the next command (e.g. while the balance is processing last command), the balance sets the CTS line to Lo. The balance confirms the level of the RTS line before outputting a set of data. If the RTS level is Hi, the balance outputs data. If the RTS level is Lo, data is not output (The data is canceled).

4-12 Settings Related to RS-232C

Concerning the RS-232C, the balance has two functions: "Data output (*dout*)" and "Serial interface (*S iF*)". Set each function as necessary.

5. ANALOG OUTPUT (OP-06)

5-1 Analog Output (OP-06) Specifications

The specifications of the analog output unit (OP-06) are as follows:

Output impedance	100 Ω or less
Linearity	$\pm 0.3\%$ or less
Output connector	7-pin DIN connector
Pin connections	Output Pin 7 GND Pin 2
Output range	0 V-1 V (With the slide switch set to "0V~") 0.2 V-1 V (With the slide switch set to "0.2V~")
Input impedance of the device connected	10 k Ω or greater

Circuit

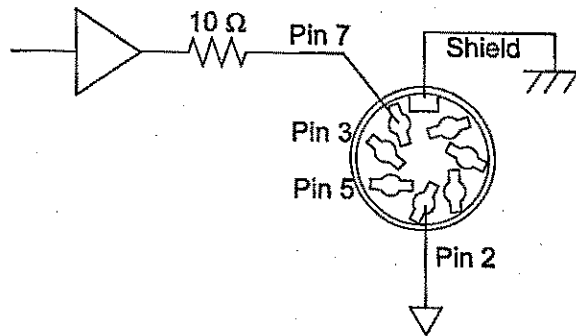

Current loop output specifications

The specifications of the current loop interface are as follows:

(For details, see "4-2 Current Loop Output Specifications" on page 15.)

Transmission system	20 mA current loop (Passive)
Transmission	Asynchronous, uni-directional (Only from the balance)
Data format	Baud rate: 600, 1200, 2400, 4800, 9600 bps Data: 7 or 8 bits Parity: Even, Odd (Data 7 bits) None (Data 8 bits) Stop bit: 1 bit Code: ASCII

Data	Current loop (20 mA)
1	20 mA
2	0 mA

Note

To use current loop, an external power supply that provides 20 mA is required. The maximum rated voltage of the current loop is 25 V.

Pin assignments

Pin No.	Description
1	No connection
2	Analog GND (0 V)
3	Sending loop
4	No connection
5	Sending loop
6	No connection
7	Analog output
Housing	Shield

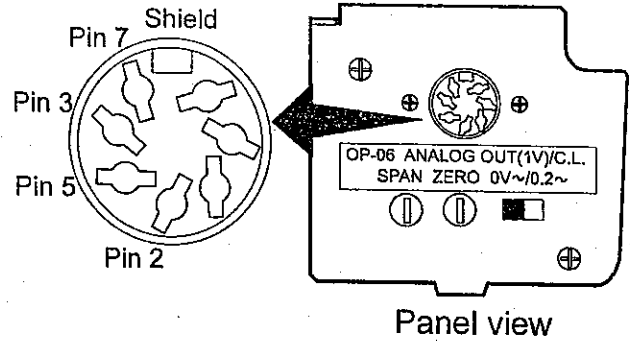

5-2 Analog Output (R_{out})

The "Analog output (R_{out})" of the function table can be selected when OP-06 is installed in the balance.

Analog output function table

Item	Parameter	Description
R_n Analog output mode	0	2-digit output Converts the consecutive 2 digits, with the digit selected in SEL as the least, to voltage and outputs.
	1	3-digit output Converts the consecutive 3 digits, with the digit selected in SEL as the least, to voltage and outputs.
	▪ 2	Net full scale output Outputs 0.000 V when the net weight is zero. Outputs 1.000 V when the net weight is full scale. Outputs 0.000 V when the display is set to zero using the RE-ZERO key.
	3	Gross full scale output Outputs 0.000 V when the gross weight is zero. Outputs 1.000 V when the gross weight is full scale. Tare operation using the RE-ZERO key will not affect the output. (Note: If the tare is extremely light, tare operation might change the zero point, thus it will affect the output.)
SEL Output digit selection		Select the least digit to be output in the mode selected in R_n . Only available when 0 or 1 is selected as the output mode.
	▪ 0	Select the first digit as the least.
	1	Select the second digit as the least.
	2	Select the third digit as the least.
	3	Select the fourth digit as the least.
	4	Select the fifth digit as the least.
5	Select the sixth digit as the least.	

▪ Factory setting

Setting example

When $R_n 0$ is set:

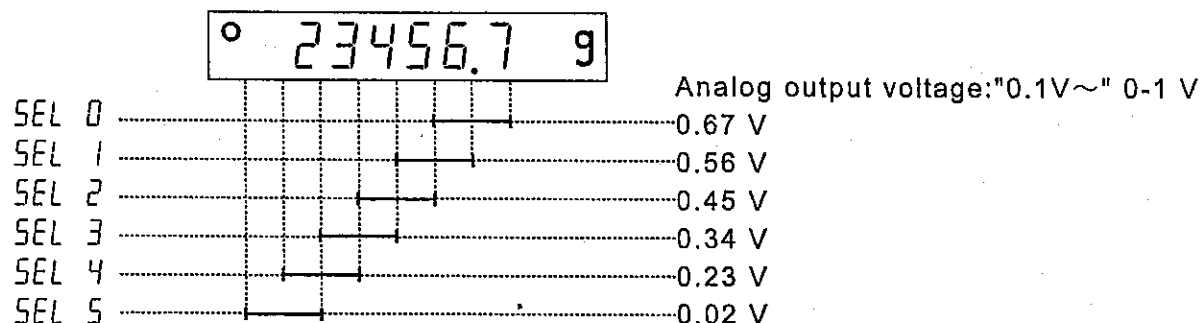

Notes

The invisible high-order digits are regarded as zero.

The invisible least digit is regarded as zero (when the minimum weighing value is turned off using the **SAMPEL** key).

When $R_n 1$ is set:

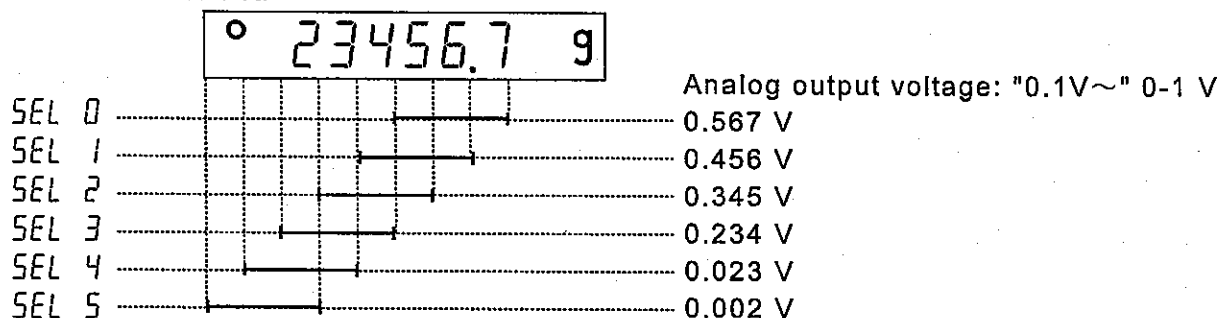

When $R_n 2$ or $R_n 3$ is set:

Model	Full scale	Model	Full scale
GX-200	200 g	GF-200	200 g
GX-400	400 g	GF-300	300 g
GX-600	600 g	GF-1200	1200 g
GX-2000	2000 g	GF-2000	2000 g
GX-4000	4000 g	GF-3000	3000 g
GX-6100	6000 g	GF-6000	6000 g
GX-6000	6000 g		
GX-8000	8000 g		

For example, when the GX-2000 displays 200 g, the output voltage of $R_n 2$ is 0.1 V (when the slide switch is set to "0V~").

$$1.000 \text{ V} \times \frac{200 \text{ g}}{2000 \text{ g}} = 0.100 \text{ V}$$

Note

"Full scale" of the full scale output mode indicates the full scale values shown in the tables above. The output voltage may exceed 1.000 V, depending on the weighing data.

For example, when the GX-2000 displays 2100 g, the output voltage is 1.05 V.

$$1.000 \text{ V} \times \frac{2100 \text{ g}}{2000 \text{ g}} = 1.05 \text{ V}$$

5-3 Switching Output Voltage

The output voltage can be switched using the slide switch on the OP-06 panel. "0V~" has been set at factory before shipment.

"0V~" (0-1 V): At zero 0.000 V At full scale 1.000 V

"0.2V~" (0.2-1 V): At zero 0.200 V At full scale 1.000 V

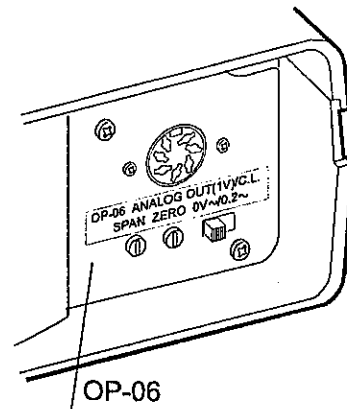

5-4 Output Voltage Fine Adjustment

The output voltage has been adjusted at the factory before shipment.

Using the ZERO and SPAN fine-adjustment knobs and a voltmeter, output voltage can be fine adjusted.

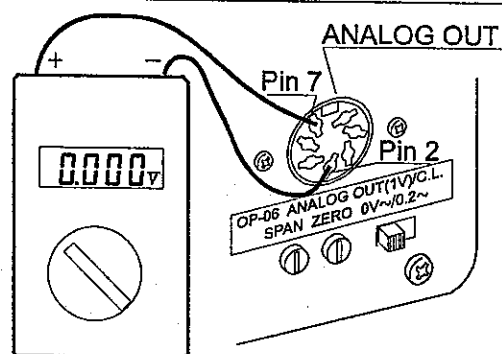

Fine-adjustment procedure

1. Turn the display off. At this time, the output voltage will be at zero. Turn the ZERO knob so that the voltmeter indicates 0.000 V when the slide switch is set to "0V~"; 0.200 V when the slide switch is set to "0.2V~".
2. While pressing and holding the **SAMPLE** and **PRINT** keys, press the **ON:OFF** key. The balance displays **P5**. At this time, a voltage of 1 V is generated. Turn the SPAN knob so that the voltmeter indicates 1.000 V.
3. Repeat steps 1 and 2 until the correct output voltage is obtained.

Display for setting the output to 0 V (0.2 V)



Display for setting the output to 1 V



5-5 Fixed Output Voltage

The output voltage is fixed under the following conditions:

1. During operations other than weighing (e.g., the display-off state, calibration) 0 V (or 0.2 V)
2. During the zeroing operation, with $R_n \ 3$: The previous output value is retained.
During the zeroing operation, with $R_n \ 0, R_n \ 1, R_n \ 2$: 0 V (or 0.2 V when the slide switch set to "0.2V~")
3. When "-E" (Weighing pan error) is being displayed: 0 V (or 0.2 V when the slide switch set to "0.2V~")
4. When "E" (Overload error) is being displayed: Output voltage is as shown below. (when the slide switch is set to "1V~")

Model	$R_n \ 0, R_n \ 1$	$R_n \ 2, R_n \ 3$
GX-200	1.000 V	1.050 V
GX-400	1.000 V	1.025 V
GX-600	1.000 V	1.017 V
GX-2000	1.000 V	1.050 V
GX-4000	1.000 V	1.025 V
GX-6100	1.000 V	1.017 V
GX-6000	1.000 V	1.017 V
GX-8000	1.000 V	1.013 V

Model	$R_n \ 0, R_n \ 1$	$R_n \ 2, R_n \ 3$
GF-200	1.000 V	1.050 V
GF-300	1.000 V	1.033 V
GF-1200	1.000 V	1.009 V
GF-2000	1.000 V	1.050 V
GF-3000	1.000 V	1.033 V
GF-6000	1.000 V	1.017 V